

! INFO !

Do not charge the battery of the towing vehicle and/or towed vehicle directly via the socket.

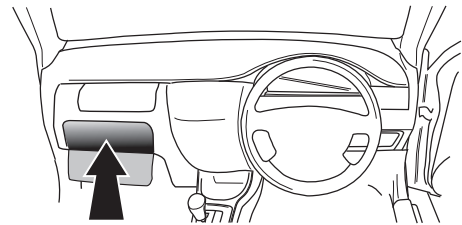

User guide



SPARE PARTS

www.ecs-electronicsuk.co.uk



Partnr.: OP-057-DLU

User Guide

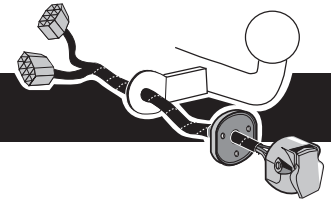

Opel Vivaro 08/2006-
Renault Trafic 10/2006-
Nissan Primastar 10/2006-

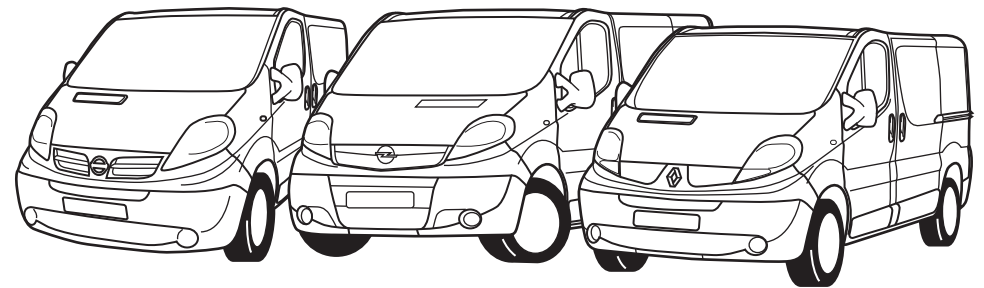

INFO

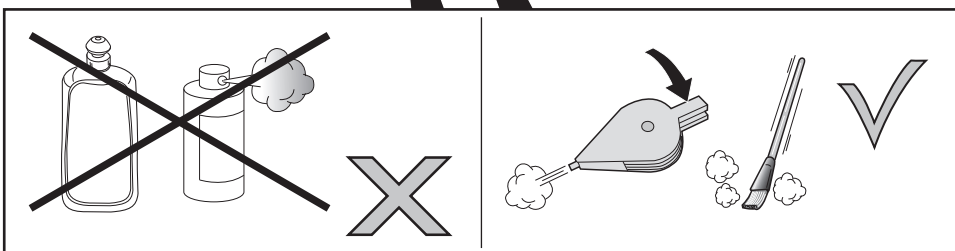
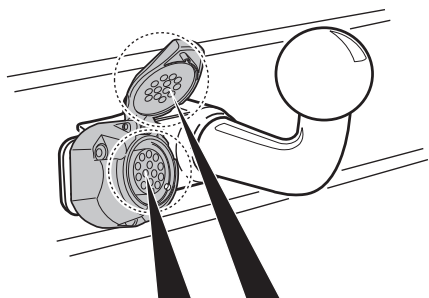
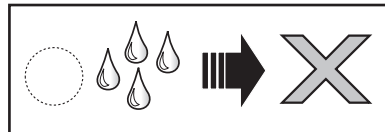
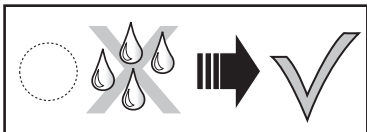
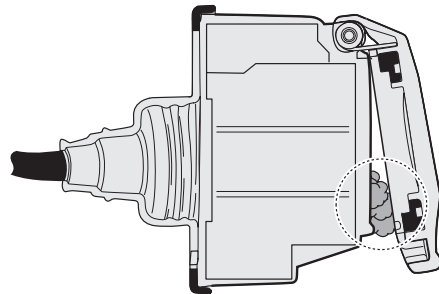
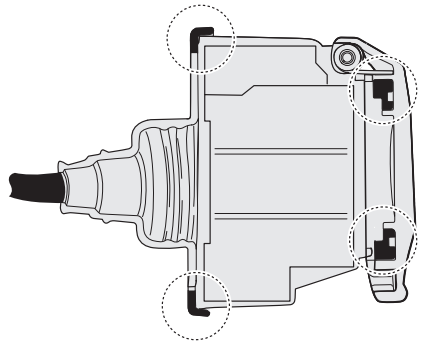
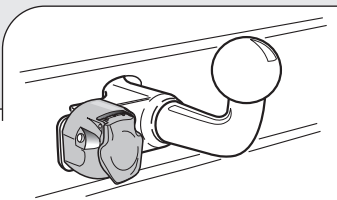
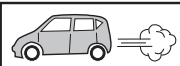

INFO

SOCKET CONNECTION

DIN/ISO 11446													
	1/L	2	3/31	4/R	5/58-R	6/54	7/58-L	8	9	10	11	12	13
Pmax	21W	2x21W		21W	52W	3x21W	52W	2x21W	180W/15Amp	180W/15Amp			
Colour	Yellow	Blue	White	Green	Brown	Red 1,00 mm ²	Black	Black/ Red	Brown/ White	Red 2,50 mm ²	White	-	White

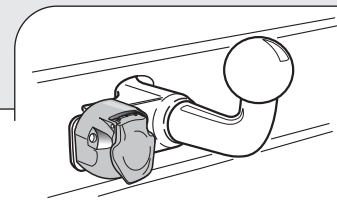

INFO : Ring.

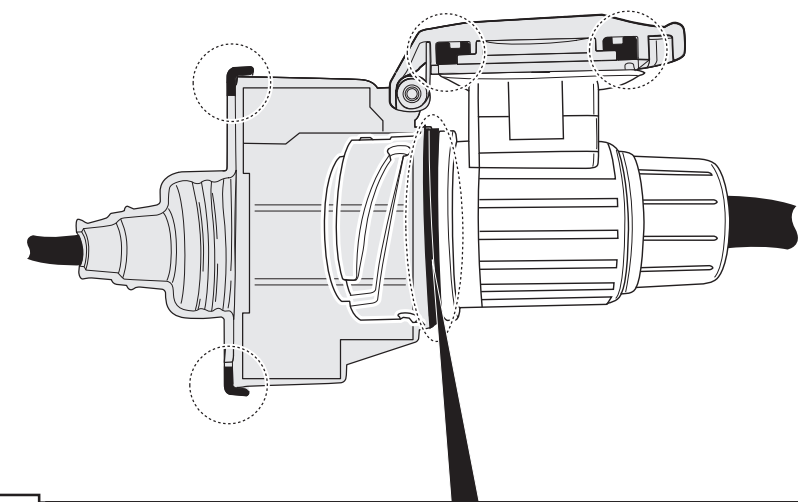
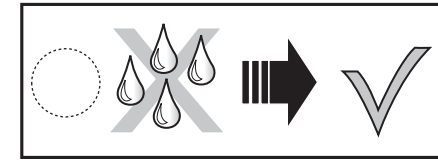
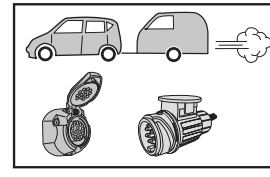

INFO

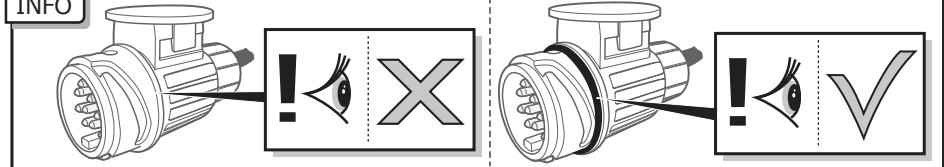

INFO : Adapt.

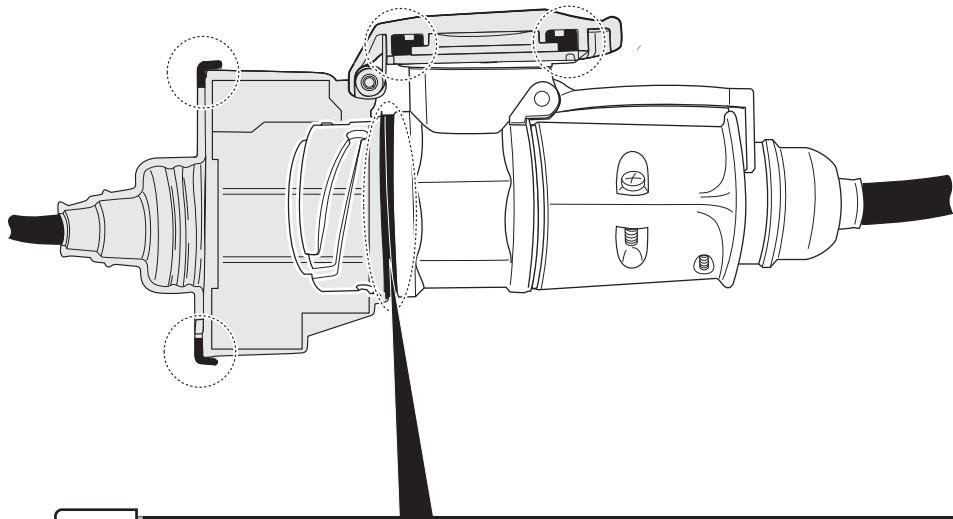
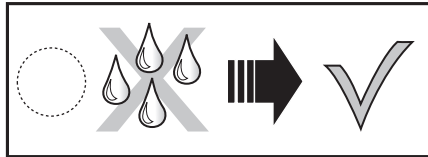
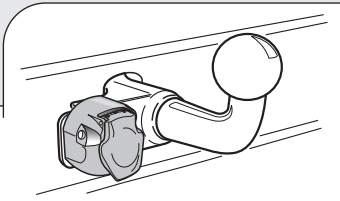
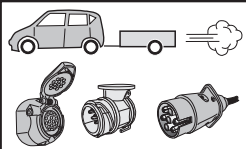

INFO

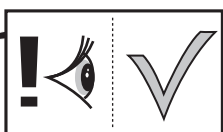
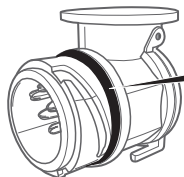
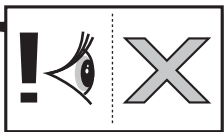
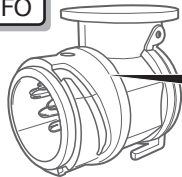

INFO : Storage

